

## HEAVY DUTY SWING-OUT VALVE

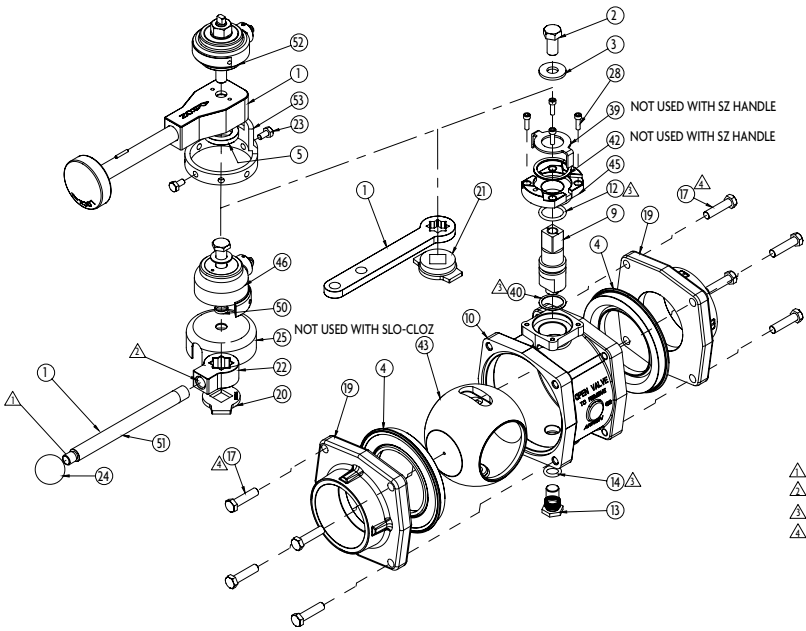

**NOTES:**

- △ USE PERMABOND LMI13 OR LOCTITE 222 AT ASSEMBLY
- △ USE PERMABOND HH120 OR LOCTITE 277 AT ASSEMBLY
- △ APPLY PARKER O-LUBE AT ASSEMBLY
- △ TORQUE TO THE FOLLOWING TORQUE

VALVE	TORQUE
8820	25-30 ft-lbs
8825	25-30 ft-lbs
8835/8835	38-40 ft-lbs

\* MAXIMUM OPERATING PRESSURE 250 PSI



**Tested... Proven... Trusted.**

ISO 9001 REGISTERED COMPANY

PHONE: 330.264.5678 or 800.228.1161 | FAX: 330.264.2944 or 800.531.7335 | [akronbrass.com](http://akronbrass.com)

REVISED: 07/14

**WARRANTY AND DISCLAIMER:** We warrant Akron Brass products for a period of five (5) years after purchase against defects in materials or workmanship. Akron Brass will repair or replace product which fails to satisfy this warranty. Repair or replacement shall be at the discretion of Akron Brass. Products must be promptly returned to Akron Brass for warranty service.

We will not be responsible for wear and tear, any improper installation, use, maintenance or storage, negligence of the owner or user, repair or modification after delivery, damage, failure to follow our instructions or recommendations or anything else beyond our control. **WE MAKE NO WARRANTIES, EXPRESS OR IMPLIED OTHER THAN THOSE INCLUDED IN THIS WARRANTY STATEMENT, AND WE DISCLAIM ANY IMPLIED WARRANTY OF MERCHANTABILITY OR FITNESS FOR ANY PARTICULAR PURPOSE.** Further, we will not be responsible for any consequential, incidental or indirect damages (including, but not limited to, any loss of profits) from any cause whatsoever. No person has authority to change this warranty.

© Akron Brass Company 2014. All rights reserved. No portion of this can be reproduced without the express written consent of Akron Brass Company.



**Style 9146**

**Field Service Kit with Metal Ball for:**

**All 8625 and 8825**

**Heavy Duty Swing-Out™ Valves (including Generation II)**

**Conversion Kit for:**

**7625 and 7825**

**Swing-Out Valves**

# PARTS LIST AND REPAIR INSTRUCTIONS FOR HEAVY DUTY SWING-OUT™ VALVES

## DISASSEMBLY

1. Turn the valve ball to the open position.  
Note: If the Valve Handle needs to be removed, the position of the Handle and Stop Plate should first be noted before disassembly.
2. This Valve is designed to “Swing Out” for easy repair.  
In order to swing the Valve, loosen the 4 sets of Adapter Bolts (17). Then remove 3 Bolt sets and rotate the Valve for easy repair. If the Valve cannot be rotated, remove the 4th set of Adapter Bolts.
3. Remove the 2 Seats (4) from the Valve Body (10). It may be necessary to partially close the Ball to grasp the lip of the Seat to remove.
4. Remove the Threaded Trunnion (13).
5. With the Valve in the open position, remove the Metal Ball (43).
6. Remove the Ball Trunnion only if leakage has been detected in this area. To remove the Ball Trunnion (9), first remove the Handle Bolt (2), Washer (3), Bearing Brake (39), and Compression Spring (42). Then push the Ball Trunnion into the Valve cavity and remove the Trunnion Bearing (40) from the top of the Ball Trunnion.

## REASSEMBLY

1. Lubricate the O-Rings (14 & 12) with Parker O-Ring Lubricant or equivalent petroleum based lubricant. Be sure not to place any excess lubricant on the Seats or Ball, as this will collect dirt that may cause excess wear.
2. If the Ball and Ball Trunnion were removed proceed as follows, if not skip to Step 8.
3. Place Trunnion Bearing (40) on the Ball Trunnion (9).
4. Place O-Ring (12) in the recess of Ball Trunnion (9).
5. Insert the Ball Trunnion into the upper trunnion hole from inside the Valve.
6. Place, Compression Spring (42), and Bearing Brake (39) into the recess.  
Align the tabs on the Bearing Brake with the slots in the Body.
7. Replace the Stop Plate (20 or 21), Handle and any connection hardware. Be sure the tabs on the Bearing Brake are fitted into the slots of the Body.
8. Rotate the Ball Trunnion to accept the Ball. Insert the Ball into the Valve.
9. Place a new O-Ring (14) in the recess of Threaded Trunnion (13) and thread the trunnion into the Valve body.
10. With the Ball in the open position, place a new Seat (4) into the recess on each side of the Valve Body.
11. Return the Valve to its original position between the flanged adapters and loosely replace the 8 Bolts.
12. Close the Valve Ball and then tighten the flange bolts. Tighten the bolts in an “X” pattern using 25-30 foot pounds of torque.

## DO NOT OVER TIGHTEN

13. Operate the Valve and inspect for leaks.

## OPERATING AND MAINTENANCE INSTRUCTIONS

Always open and close valves slowly to minimize the effects of water hammer. Occasionally, flow water through all valves to clear dirt and debris.

Do not exceed 250 psi operating pressure.

See Drawing on opposite page.

5. Install the threaded trunnion so that it fits into the hole in the ball. Tighten the trunnion.
6. Place the new seats into the recesses on either side of the valve body (21).
7. Swing the valve body back into line or install the assembly. Loosely install the adapter bolts.
8. Turn the ball to the closed position.  
Caution: The ball must be in the closed position before the adapter bolts are tightened.
9. Tighten the adapter bolts evenly in an X pattern using 25-30 foot pounds of torque.

**DO NOT OVERTIGHTEN.**

10. Operate the valve and test for leakage.

**MAINTENANCE INSTRUCTIONS**

Do not lubricate the ball or seats. Lubricants can collect dirt and grit which may cause excessive wear. Occasionally, flow water through all valves to clear dirt and debris.

**OPERATING INSTRUCTIONS**

Always open and close valves slowly.

Do not exceed 500 psi.

With SZ handles, always make sure that the handle has been tightened whenever the valve handle is released.

ITEM NO.	DESCRIPTION	QUANTITY	8820	8825	8830/8835
1	HANDLE R-1 STANDARD LENGTH	1	721508	115613	115613
1	TS HANDLE ASSEMBLY	1	78250563	78250563	78250563
1	TSC HANDLE ASSEMBLY	1	78250565	78250565	78250565
1	SZ HANDLE ASSEMBLY	1	78250135	78250135	78250135
2	BOLT	1	761045	761045	761045
3	WASHER	1	784120	784120	784120
4*	SEAT	2	769561	769537	769181
5	BRAKE WASHER (SZ HANDLE) ◊	1	784213	784213	784213
9	BALL TRUNNION	1	772262	772262	772263
10	BODY	1	122026	122027	122028
12*	O-RING	1	757010	757010	757010
13	THREADED TRUNNION	1	773094	773094	773095
14*	O-RING	1	757198	757198	757217
17	BOLT (FLANGE)	8	761092	761048	761058
19	VALVE ADAPTER	2	**	**	**
20	STOP PLATE (TS/TSC HANDLE)	1	742073	742073	742073
21	STOP PLATE (R-1 HANDLE)	1	742095	742095	742095
22	HANDLE HUB (TS/TSC HANDLE)	1	721278	721278	721278
23	SCREW (SLO-CLOZ SZ HANDLE) ◊◊	2			761050
24	BALL (TS/TSC HANDLE)	1	703080	703080	703080
25	COVER (TSC HANDLE)	1	109177	109177	109177
28	SCREW (BONNET)	4	765028	765028	765028
39	BEARING BRAKE	1	704788	704788	704788
40	TRUNNION BEARING (GEN 2)	1	703925	703925	703925
42	WAVE SPRING	1	768291	768291	768291
43*	BALL (GEN 2)	1	703930	803132	703933
45	BONNET	1	703806	703806	703806
46	SLO-CLOZ ASSEMBLY( R1 & TS HANDLE)	1	78750001	78750001	78750001
51	ROD (TS/TSC HANDLE) STD	1	109146	109146	109146
52	SLO-CLOZ ASSEMBLY ( SZ HANDLE)	1			76750004
53	COLLAR (SLO-CLOZ SZ HANDLE) ◊◊	1			761050
<b>COMPONENT PARTS OF ADAPTERS NOT ILLUSTRATED</b>					
	ADAPTER PLUG-3/4"		744018	744018	744018
	ADAPTER SWIVEL GASKET		714013	714019	3"- 714022
	SCREEN			769027	3 1/2"- 714023
	BALL BEARING ††		42	38	769241
	1/4" ADAPTER/BODY PLUG		744011	744011	3"- 47
	SWIVEL (NH)- CHROME ++		119451	101343	3 1/2" - 53
	SWIVEL PLUG		765008	742023	3"- 100066
					3 1/2"- 100067
					742023

\*PARTS IN SERVICE KITS

\* \*SEE CURRENT CATALOG FOR COMPLETE LIST

†† PACKET OF 50 LOCKING BALLS - 2" P/N 109042; 2 1/2" - 3 1/2" P/N 109041

++ FOR OTHER THREADS ORDER BY DESCRIPTION AND THREAD SIZE (ODM AND TPI) OR BY THREAD CODE

◊USED WITH SZ HANDLE ONLY IN PLACE OF ITEMS 39 AND 42

◊◊INCLUDED IN SLO-CLOZ ASSEMBLY(SZ HANDLE) -ITEM 52

## PARTS LIST AND INSTRUCTIONS FOR CONVERTING A STYLE 7625 OR 7825 TO A metal BALL

Style 7625  
Non Tork-Lok®  
with Trunnion Re-  
taining  
Plate (#7)

Style 7825  
Tork-Lok with  
large stops built  
into Trunnion  
Retaining  
Plate (#7)

Style 7625  
Non Tork-Lok with  
stops  
in valve body and  
separate stop  
plate (#4)

Style 7825  
with separate  
stop  
plate (#4)

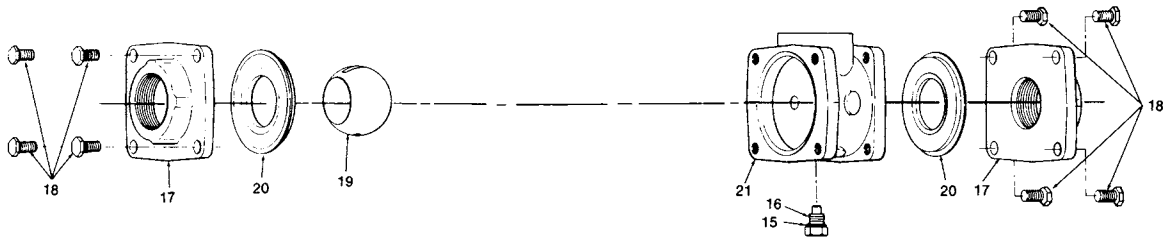
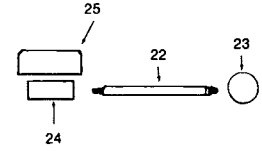
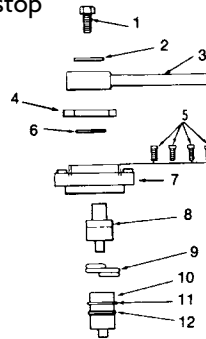
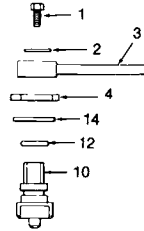
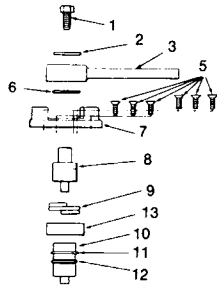
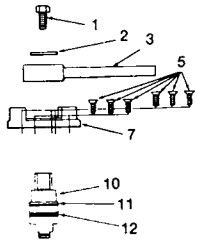

ITEM NO.	DESCRIPTION	7625 with Stops in Trunnion Plate	7825 with Stops in Trunnion Plate	7625 with Separate Stop Plate	7825 with Separate Stop Plate
1	Handle Bolt	761065	761065	7-61-065	7-61-065
2	Handle Washer	784120	784120	7-84-120	7-84-120
3	Handle*				
4	Stop Plate for SZ or TS Handles	N/A	N/A	742073	742073
4	Stop Plate for RI Handle	N/A	N/A	742095	742095
5	Trunnion Plate Screws	767090 (6)	767090 (6)	N/A	765028 (4)
6	Handle O-Ring	N/A	757054	N/A	757284
7	Trunnion Retaining Plate	105707	†	N/A	742089
8	Handle Trunnion	N/A	772142	N/A	772142
9	Tork-Lok Spring	N/A	768210	N/A	768210
10	Ball Trunnion	7-72-088	773149	772115	773149
11	Retaining Ring	7-58-058	758058	N/A	758154
12	Trunnion O-Ring	7-57-010	757010	757226	757010
13	Tork-Lok Sleeve	N/A	769172	N/A	N/A
14	7600 Handle Spacer	N/A	N/A	769310	N/A
15	Threaded Trunnion O-Ring	757198	757198	757198	757198
16	Threaded Trunnion	773094	773094	773094	773094
17	Complete Adapters*				
18	Adapter Bolts (8)	761048	761048	761048	761048
19	Ball	803132	803132	803132	803132
20	Seats (2)	769537	769537	769537	769537
21	Valve Body	105287	105287	106310	105287
22	TS Handle Rod – 9 1/4"	N/A	109146	N/A	109146
23	TS Handle Ball	N/A	703080	N/A	703080
24	TS Handle Hub	N/A	721278	N/A	721278
25	TS Handle Cover	N/A	109177	N/A	109177

\*See current catalog for complete handles and adapters.

† Item not available. Must replace body sub-assembly. P/N 7825-0555

## DISASSEMBLY – BALL AND SEATS

**NOTE:** This kit includes extra O-rings for the different variations of valve. Identify the correct replacement O-rings when removing the old ones.

1. Turn the valve to the open position.
2. If the valve can be rotated out of line, remove three pairs of adapter bolts (18) and loosen the fourth pair. Swing the valve out of the line. If the valve cannot be rotated out of line, remove all eight adapter bolts and take the valve out completely.  
**NOTE: If it is necessary to remove the handle, mark the position of the handle in relation to the ball position, and the orientation of the stop plate (4) if so equipped.**
3. Remove the two seats (20) from the valve body (21). It may be necessary to partially close the ball and grasp the inside lip of the seat.
4. Remove the threaded trunnion (16). If necessary, use fine emery paper to clean up the smooth portion that fits into the ball. The ball should fit loosely on the trunnion.
5. Rotate the handle so that the slot in the top of the ball is parallel to the waterway. Remove the ball (19).

## DISASSEMBLY – HANDLE AND TOP TRUNNION(S)

**Note:** If the valve is equipped with an electric actuator, do not disassemble this portion of the valve. The water tight seal will be broken and water may leak into the electronic controls chamber. If the valve is equipped with a standard type handle, it is not normally necessary to replace the O-ring under the handle or on the ball trunnion. Do not disassemble this portion of the valve unless there is a leak.

1. Remove the handle bolt (1) and washer (2).
2. Note the position of the handle relative to the groove in the top of the trunnion for reassembly purposes. Remove the handle (3) and the stop plate (4), handle O-ring (6) and handle spacer (14) if so equipped.
3. If the valve includes a trunnion retaining plate (7), note the position for reassembly purposes. Remove the trunnion plate screws (5).  
**Note: With flat head screws, one screw may be tighter than the others. Try to loosen all remaining screws before using excessive force on one. If the valve does not have a retaining plate, remove the trunnion (10) by pushing it into the valve body.**
4. Remove the trunnion retaining plate (7). If this plate was secured with socket head screws, the handle trunnion (8) should remain in the plate.
5. Remove the handle trunnion (8), if separate.
6. Remove the Tork-Lok® sleeve (13) and spring (9) subassembly if applicable.  
Caution: Do not remove the spring from inside the sleeve.
7. Remove the ball trunnion (10) by pushing it from the inside of the valve.

## REASSEMBLY – HANDLE AND TOP TRUNNION(S)

**Note:** Lubricate all O-rings with Parker O-Ring Lube or equivalent petroleum-based lubricant.

1. Replace the O-ring (12) on the ball trunnion (10) and reinstall the trunnion in the valve body.
2. Replace the Tork-Lok sleeve (13) and spring (9) sub-assembly and handle trunnion (8) if so equipped.  
**Note:** The ears of the Tork-Lok spring must be aligned with the corresponding recess of the ball trunnion. The pilot shaft of the handle trunnion must fit into the hole in the center of the ball trunnion.
3. Reposition the trunnion retaining plate (7), if so equipped, and install the screws (5).  
**Note: For Tork-Lok valves with flat head screws, tighten all six screws until they just touch the plate before fully tightening any one screw. Tighten them in a criss-cross pattern. There should be a small gap between the plate and the valve body.**
4. Install the handle O-ring (6), style 7600 handle spacer (14), and stop plate (4) as required.
5. Position the handle in the proper position, apply a small amount of Loctite 222 or equivalent to the handle bolt (1) and install the bolt with the handle washer (2).  
Immediately test the operation of the handle. If it appears to be hard to turn, loosen the handle bolt approximately 1/4 turn.

## REASSEMBLY – BALL AND SEATS

1. Install the new O-ring (15) on the threaded trunnion (16).
2. Use a 10" or larger flat file to clean up the flat surface of the adapters and mating surfaces of the valve body. Remove any paint, corrosion or raised lip around the bolt holes.  
**Caution: Always file diagonally and keep the file touching both sides of the valve body. The surfaces must remain flat.**
3. Rotate the handle so that the flats on the sides of the ball trunnion (10) are parallel to the waterway.
4. Install the new ball (19) over the ball trunnion and hold it in position.  
**Note: The ball included with this kit is a direct replacement when repairing a valve with a plastic ball.**